

THE PROPERTY OF THE DRAWING IS ESTABLISHED BY LAW. IT IS FORBIDDEN TO PRODUCE OR SHOW IT TO THIRD PART. WITHOUT A WRITTEN AGREEMENT.

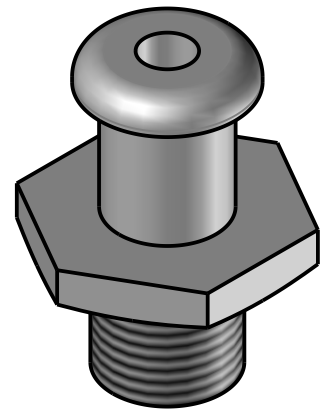
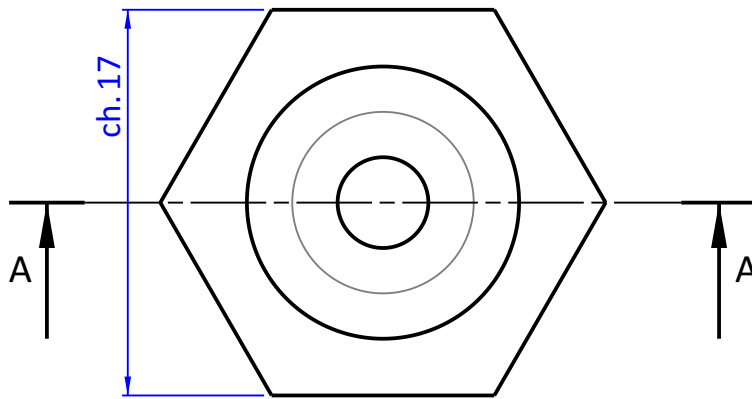
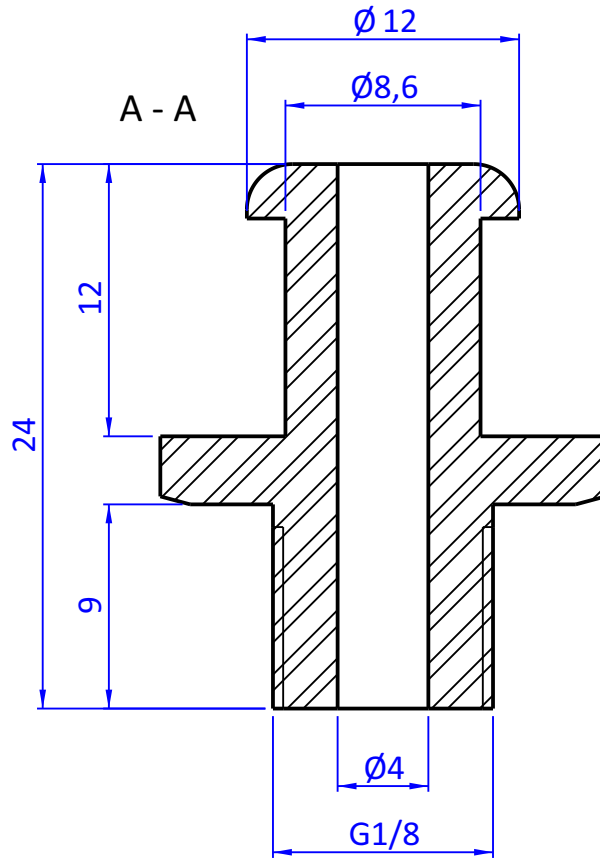

Format A4 UNI 936-76	GENERAL TOLERANCE UNI - ISO 2768 CLASSE f	DESCRIPTION CA.08.09.037	DESIGNED FROM FPS Automation		REVIEW A
			DATE 02/09/2022	WEIGHT 0,005kg	
			CODE CA.08.09.037		